

An aerial photograph of a modern backyard. A rectangular swimming pool with clear blue water is the central feature. The pool is surrounded by a light-colored stone patio. To the left of the pool, there are two white lounge chairs and a small white circular table with a chair. To the right, there is a seating area with several wooden chairs and a small table. The pool is bordered by a strip of dark gravel. The patio is interspersed with various green plants and grasses. The overall scene is bright and sunny, with shadows cast across the patio and pool deck.

PERMACON

Landscape Products

20
24

Rediscover the beauty of the outdoors and create your own haven of peace with our exclusive and innovative products.

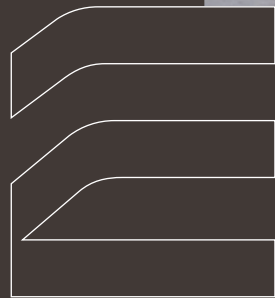



28

Alternative Landscaping

- 30 Artex Panel System
- 31 Orion Firepit

32

Slabs

- 34 Cassara Large Rectangle
- 35 City
- 36 Esbelto
- 36 Esbelto DuraFusion 
- 37 Mega Melville
- 38 Melville 60
- 38 Melville 60 Small Rectangle
- 38 Melville 60 DuraFusion 
- 40 Melville 24 x 24
- 41 Metrik
- 42 Mondrian Plus 50
- 43 Mondrian Plus 60
- 43 Mondrian Plus 60 Small Rectangle
- 44 Rosebel
- 46 Vertex *New*
- 45 Wilfrid

48

Pavers

- 50 Brooklyn *New*
- 51 Capio *New*
- 52 Cassara Large Rectangle
- 53 Cassara Verde
- 54 Esbelto DuraFusion 
- 55 Mega Melville
- 56 Melville 80
- 56 Melville 80 Small Rectangle
- 56 Melville 80 DuraFusion 
- 58 Melville Plank
- 59 Mondrian Plus 80
- 59 Mondrian Plus 80 Small Rectangle
- 60 Paleo Plus
- 60 Trafalgar 60
- 61 Vendome 60
- 61 Vendome 80
- 62 Virage
- 63 Zen

64

Walls

- 66 Celtik
- 67 Grande
- 68 Lafitt Tandem
- 69 Melville Tandem
- 70 Orion
- 71 Urbano
- 72 Vario

74

Capping

- 76 Lafitt Plus
- 78 Laguna
- 79 Leno Bullnose 
- 79 Leno Lafitt *New*
- 79 Leno Straight *New*
- 80 Marina
- 81 Melville Plus 60 and 90 *New*
- 83 Mondrian Plus

Steps

- 77 Lafitt Plus
- 82 Melville Plus 60 and 90

Mega Steps

- 86 Mega Lafitt Plus
- 87 Mega Melville Plus

88

Curbs

- 90 Celtik
- 90 Mega Celtik
- 91 Lafitt
- 92 Melville
- 93 Novo *New*

94

Mirage Porcelain Tiles

- 95 Noon
- 95 Quarziti 2.0

Miscellaneous

- 96 Polymeric Sand
- 97 Tools available at permacon.ca
- 98 Warranty

More than 70 years of expertise

Elevation

In its 9 manufacturing plants in Quebec and Ontario, Permacon manufactures increasingly innovative and trendy concrete products.

Engagement

Permacon is committed to offering high-quality products that exceed the expectations of its customers and partners.

Ecology

In its mission for a greener, more sustainable future, Permacon manufactures products locally, thereby reducing its carbon footprint. Our circularity strategy means that concrete excess from our manufacturing process is reused.

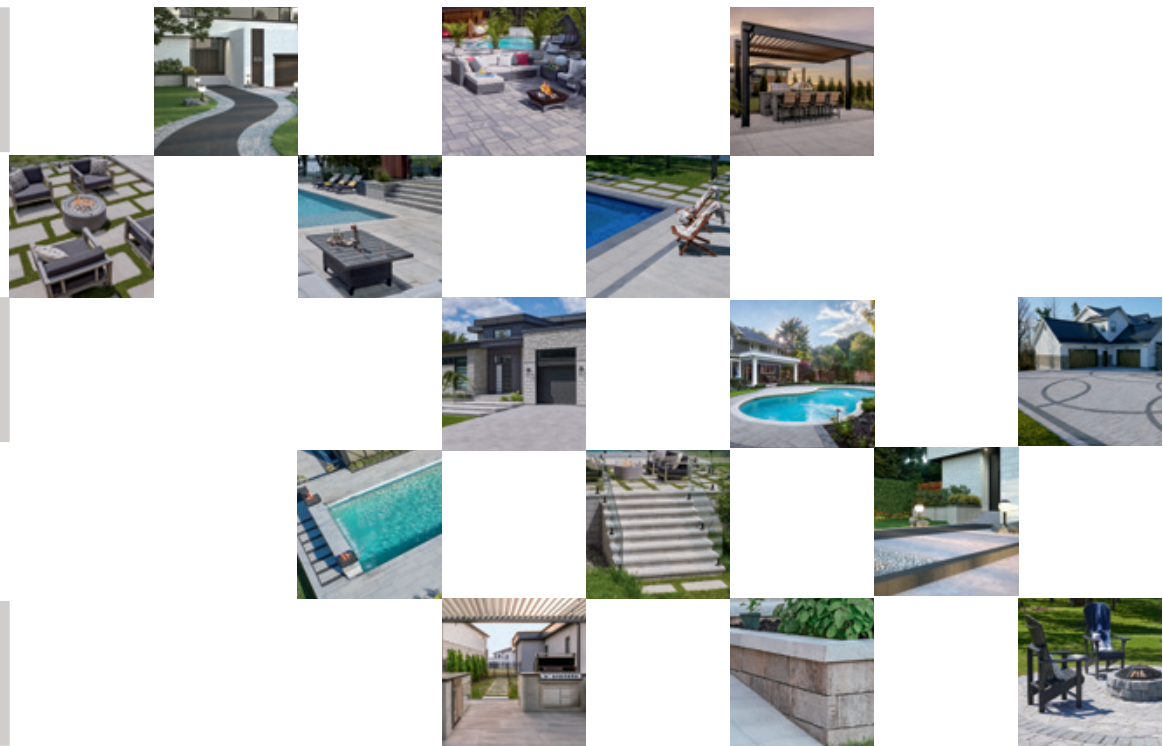

PERMACON
A CRH COMPANY



VERTEX Slab *New*

Elevate your design with our trapezoidal-shaped slabs for an exceptional outdoor space. P 46



BROOKLYN Paver *New*

Textured pavers with rich, silky colours, evoking the natural stone of the past. P 50



CAPIO Paver *New*

Incorporate the Capio paver into your designs, its small format is ideal for creating curves. P 51



LENO Capping *New*

Our popular elongated capping now available with a straight finish or our Lafitt texture. P 79

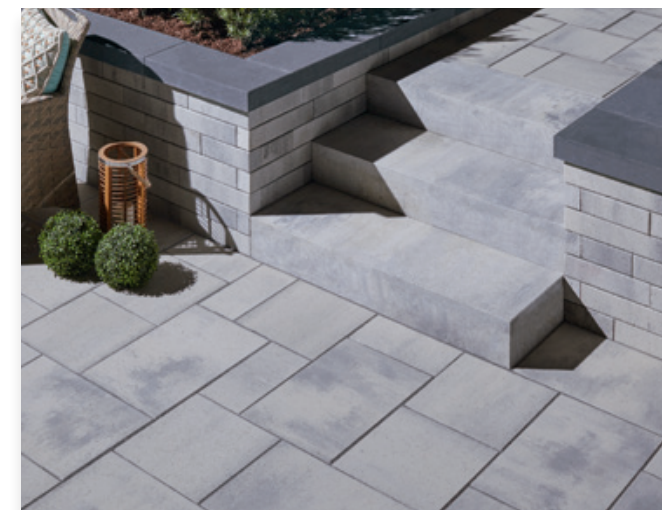

MELVILLE PLUS 90 Capping *New*

Now available in two heights (60 and 90 mm), this smooth capping adds a modern touch to your design. P 81



NOVO Curb *New*

This innovative mega-size curb features a visual illusion effect and smooth texture, perfect for contemporary design. P 93

Legend

- Pedestrian
Designed to withstand pedestrian traffic
- Vehicular
Designed to withstand vehicular traffic
- Permeable
Designed to allow runoff water to pass through

Trademarks, Patents and Industrial Design

Most of our products are protected by patent and industrial design owned by Oldcastle Building Products Canada, Inc. except for those indicated otherwise.
Vendome® Pavers: Canada and United States. Patented, United States, Canada, Mexico and Europe
Lafitt® Tandem® Wall: Patented, Canada, United States and Europe
Rosebel® Slabs: Patented, Canada, United States, Mexico
ARTEX® Panel System: Patent pending, Canada, United States and Europe

- Prestige
- New
- Ecological
-

2024 Innovations



In harmony with the environment

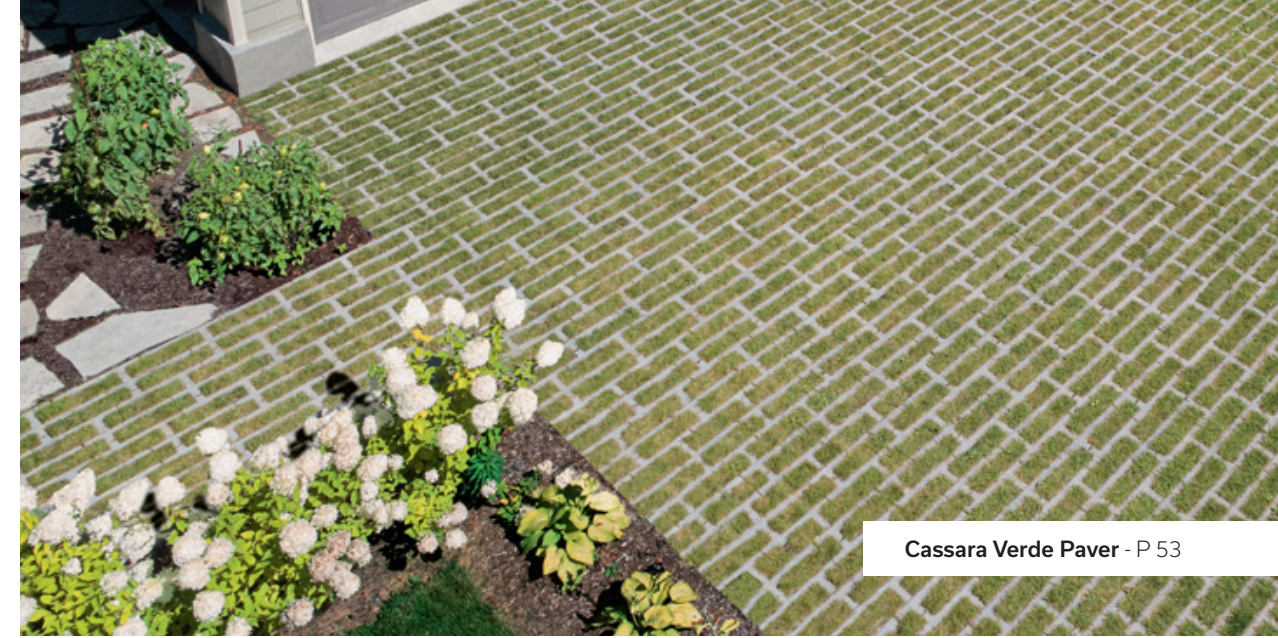

Cassara Verde Paver - P 53



Mega Melville Slab - P 37



Virage Paver - P 62

If you want to support a more sustainable approach to landscaping, consider incorporating our permeable pavers into your ecological creations.

Our range of permeable pavers filter runoff water and combat heat islands in urban environments.



ECOLOGICAL
Eco-friendly products for sustainable design.



LOCAL PRODUCTION
Commitment to the community and the local economy.



ZERO EXCESS
Zero excess approach to reduce our impact on the environment.



PERMEABLE
Permeable pavers to protect our water resources.





Inspired **by nature**



Each landscape is unique and presents challenges for achieving a design that is both respectful of nature and sustainable. The different finishes, textures and colours of Permacon's products extend interior life to the outdoors. The backyard is inspired by the architecture of the residence and maintains the natural beauty of the site.





Mega Melville Slab Range Scandina Grey - P 37



Mega Melville Slab Range Scandina Grey - P 37 | Mega Melville Plus Step Range Scandina Grey - P 87

Transform your large outdoor spaces into a haven of tranquility with our refined-style Mega Melville slabs and create a warm and welcoming space around your fireplace for unforgettable moments with your loved ones.

Large Spaces

Pair our landscape and masonry products to create your outdoor dream space. To define living spaces in large areas, match the Mondrian stone in Range Newport Grey from our masonry product range to the slabs and pavers offered in the same colour to create a refined design in harmony with nature.



Combine our pavers, slabs and cappings to create unique areas that reflect your style and personality.





Landscaping Tailored to your Tastes

Choose products from our Melville collection to create a cottage atmosphere in your backyard. Transform your outdoor space into a cozy outdoor dining room where every meal becomes an open-air gourmet experience.







Mega Melville Paver Range Scandina Grey and Rockland Black - P 55

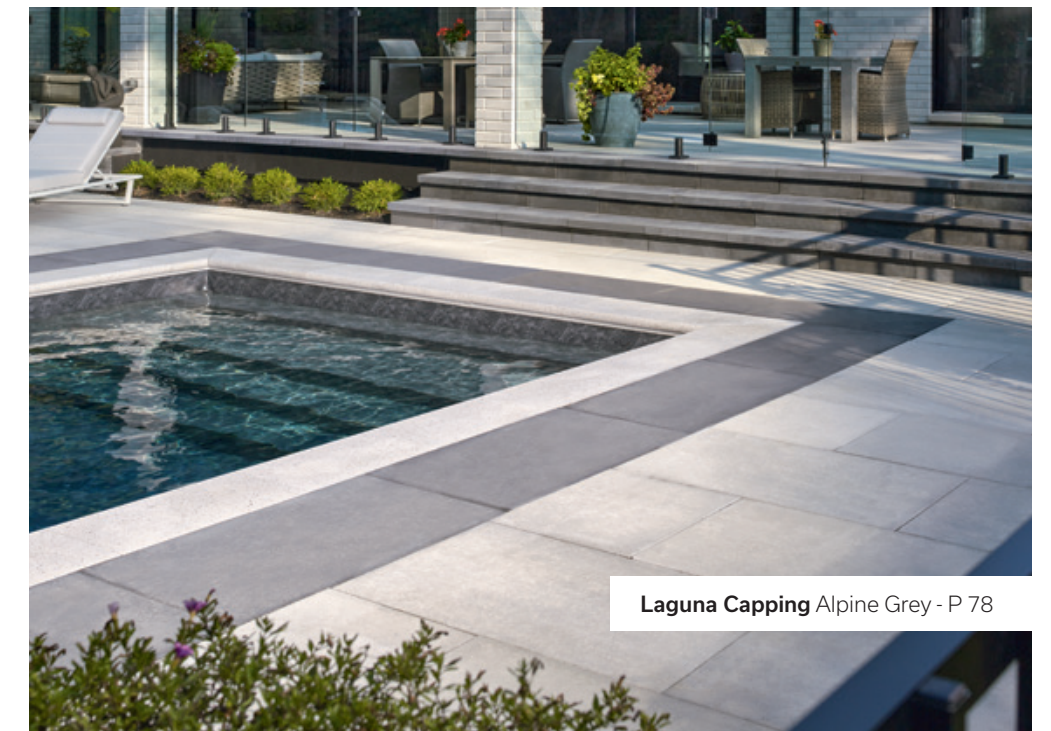

Laguna Capping Alpine Grey - P 78

Your backyard with Mega Melville slabs in Range Scandina Grey becomes welcoming and inviting, and the driveway, with matching pavers in the same colour, extends this harmony.





Melville Tandem Wall Range Shaded Grey - P 69



Melville 80 Paver Range Chambord Grey and Range Shaded Grey - P 56



Textures and Finishes

smooth 

textured 

Explore our smooth and textured surface collections. One represents refinement for modern spaces and the other evokes rusticity for natural and organic spaces.

Whatever the style you choose, these collections combine delicacy and natural beauty, offering an outstanding landscaping experience.



Imagine and bring to life your dream outdoor space. Our landscape products, with their smooth or textured surfaces and numerous finishes and colours, offer endless possibilities.

30 Artex Panel System

31 Orion Firepit

Alternative Landscaping



Artex Panel System



Artex Panel System
Range Scandina Grey

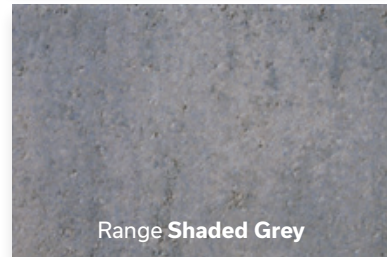

18 x 36 Panel
76 x 457 x 914 mm
3 x 18 x 36 in.



6 x 36 Capping
76 x 152 x 914 mm
3 x 6 x 36 in.

Resources and inspirations
Download our Artex Idea Guide for a wealth of ideas.



Orion Firepit



Orion Firepit
Range Scandina Grey



540 x 1016 x 1016 mm
21 3/16 x 40 x 40 in.



- 34 Cassara Large Rectangle
- 35 City
- 36 Esbelto
- 36 Esbelto DuraFusion 
- 37 Mega Melville
- 38 Melville 60
- 38 Melville 60 Small Rectangle
- 38 Melville 60 DuraFusion 
- 40 Melville 24 x 24
- 41 Metrik
- 42 Mondrian Plus 50
- 43 Mondrian Plus 60
- 43 Mondrian Plus 60 Small Rectangle
- 44 Rosebel
- 46 Vertex *New*
- 45 Wilfrid

Slabs

Cassara Large Rectangle Slab



Cassara Large Rectangle Slab
Range Shaded Grey

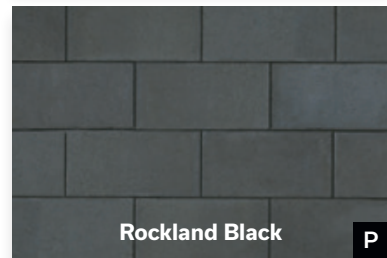
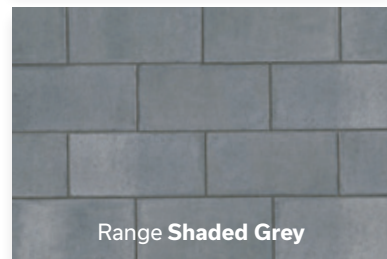
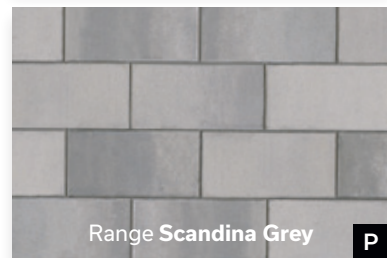
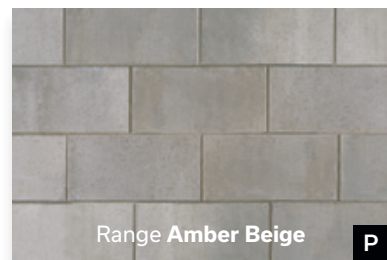

Large Rectangle
60 x 300 x 700 mm
2 3/8 x 11 13/16 x 27 9/16 in.

City Slab



City Slab
Alpine Grey

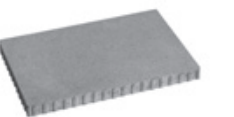

60 x 500 x 750 mm
2 3/8 x 19 11/16 x 29 1/2 in.

Esbelto Slab



Esbelto Slab
Range Scandina Grey

Mega Melville Slab



Mega Melville Slab
Range Scandina Grey

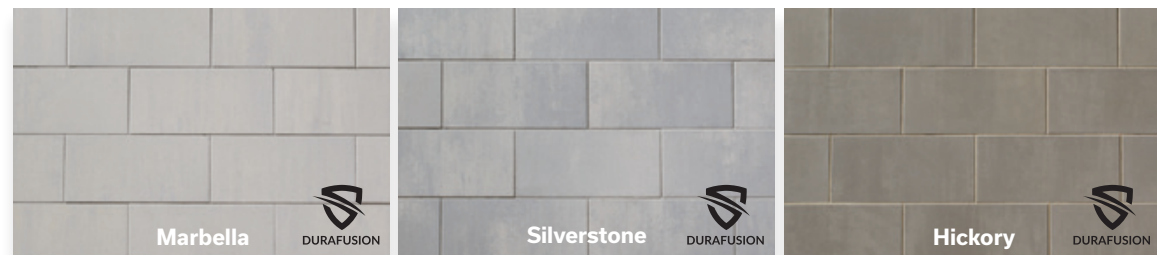

60 x 305 x 610 mm
2 3/8 x 12 x 24 in.

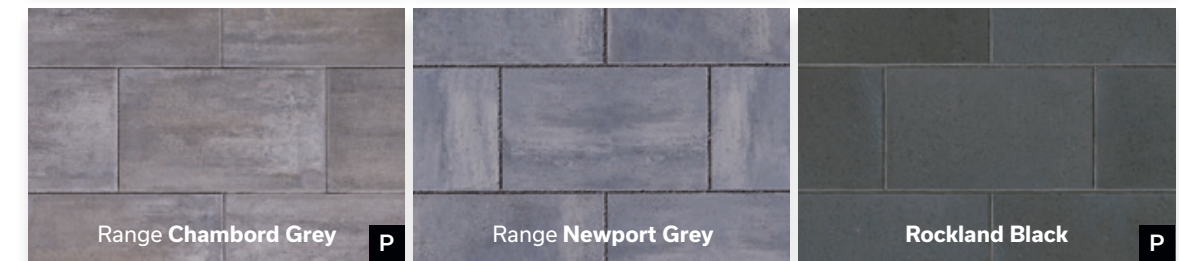

60 x 570 x 950 mm
2 3/8 x 22 7/16 x 37 3/8 in.







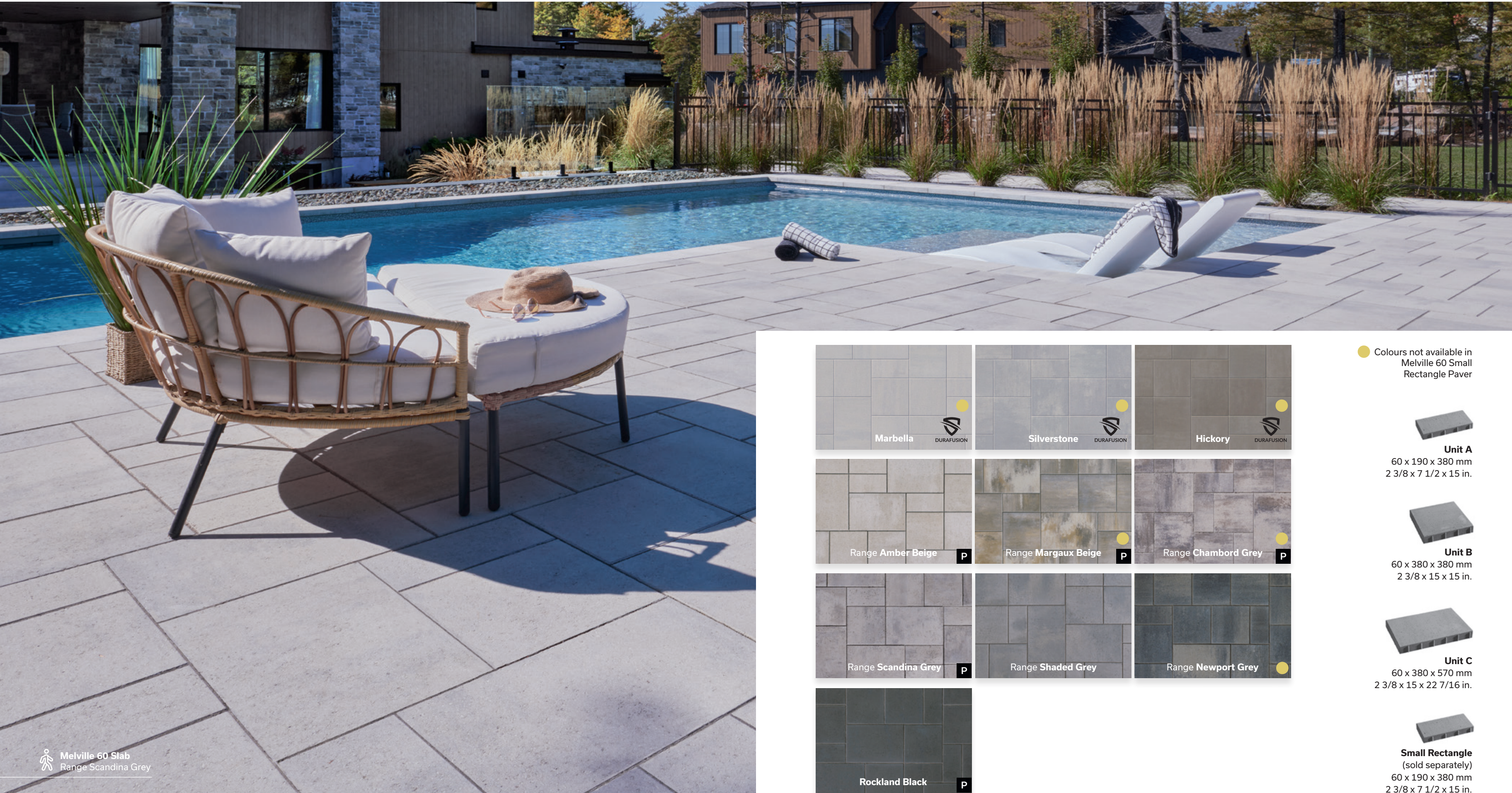







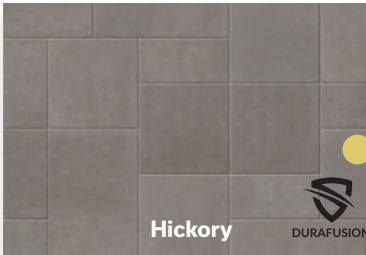

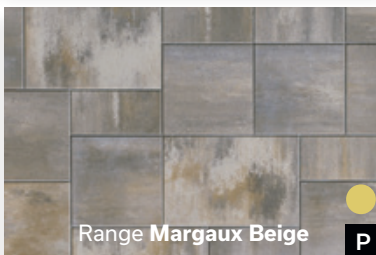

Melville 60 Slab

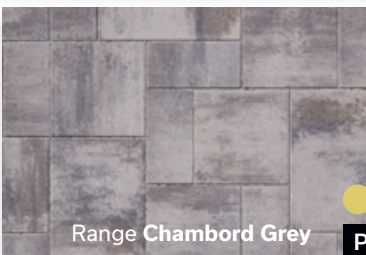
For more information  

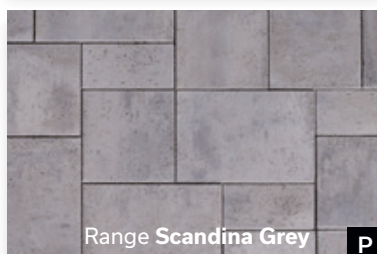
smooth  

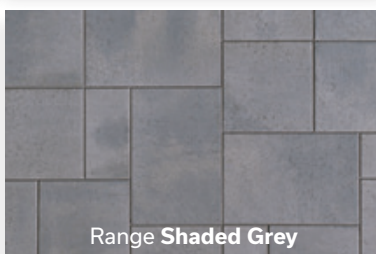
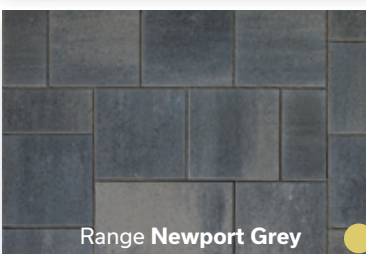

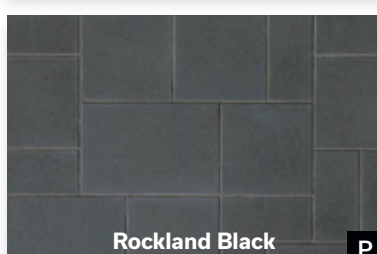

 Melville 60 Slab
Range Scandina Grey

 Marbella 	 Silverstone 	 Hickory 
 Range Amber Beige 	 Range Margaux Beige 	 Range Chambord Grey 
 Range Scandina Grey 	 Range Shaded Grey	 Range Newport Grey 
 Rockland Black 		

 Colours not available in Melville 60 Small Rectangle Paver

Unit A
60 x 190 x 380 mm
2 3/8 x 7 1/2 x 15 in.

Unit B
60 x 380 x 380 mm
2 3/8 x 15 x 15 in.



Unit C
60 x 380 x 570 mm
2 3/8 x 15 x 22 7/16 in.

Small Rectangle
(sold separately)
60 x 190 x 380 mm
2 3/8 x 7 1/2 x 15 in.

Melville 24 x 24 Slab

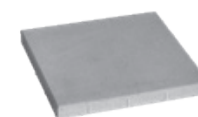
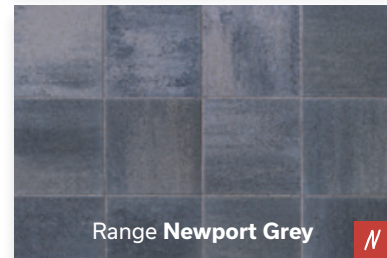
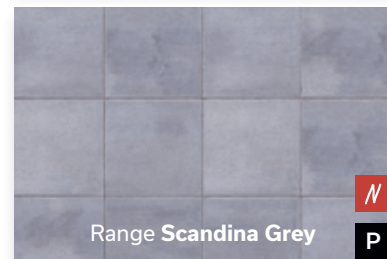
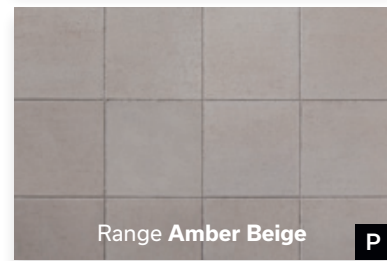
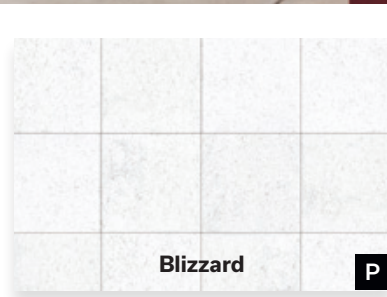

Melville 24 x 24 Slab
Range Amber Beige



60 x 610 x 610 mm
2 3/8 x 24 x 24 in.

Metrik Slab



Metrik Slab
Range Scandina Grey

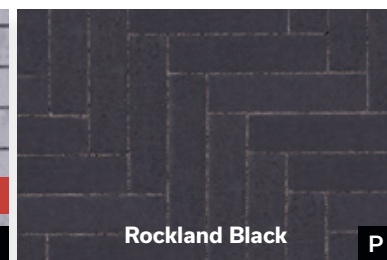

60 x 70 x 280 mm
2 3/8 x 2 3/4 x 11 in.

Mondrian Plus 50 Slab



Mondrian Plus 50 Slab
Range Margaux Beige

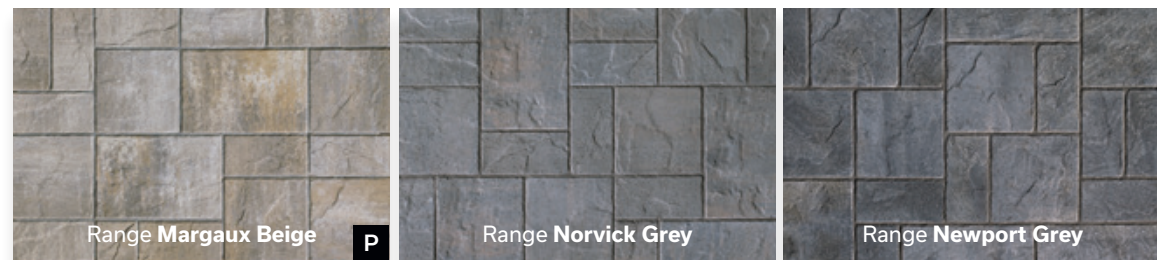

- Unit A**
50 x 190 x 380 mm
2 x 7 1/2 x 15 in.
- Unit B**
50 x 380 x 380 mm
2 x 15 x 15 in.
- Unit C**
50 x 380 x 570 mm
2 x 15 x 22 7/16 in.

Mondrian Plus 60 Slab



Mondrian Plus 60 Slab
Range Margaux Beige

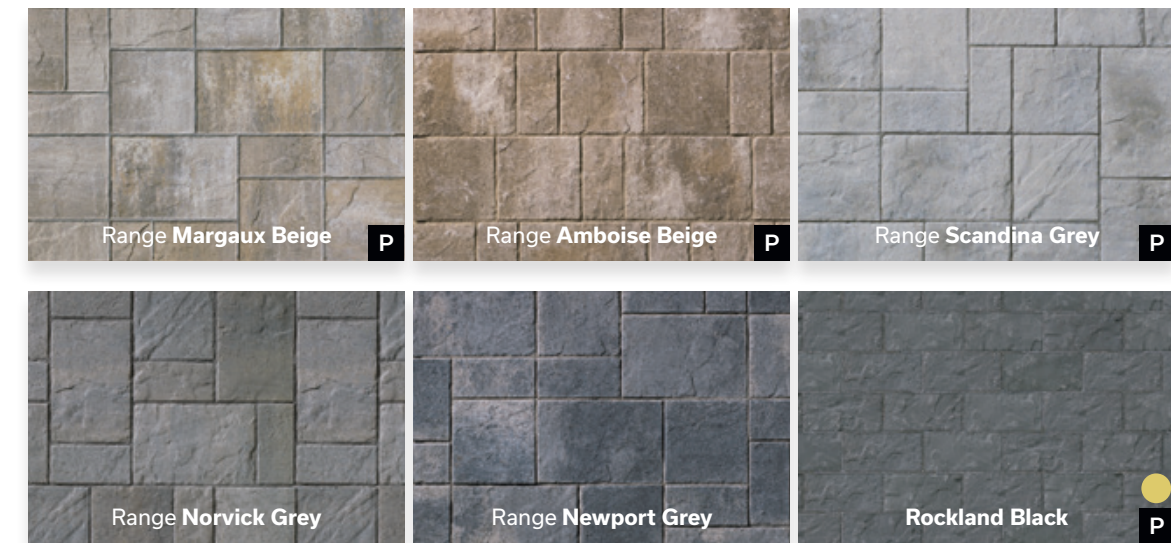

● Colour available in Mondrian Plus 60 Small Rectangle Paver only

- Unit A**
60 x 165 x 330 mm
2 3/8 x 6 1/2 x 13 in.
- Unit B**
60 x 330 x 330 mm
2 3/8 x 13 x 13 in.
- Unit C**
60 x 330 x 495 mm
2 3/8 x 13 x 19 1/2 in.
- Small Rectangle**
(sold separately)
60 x 165 x 330 mm
2 3/8 x 6 1/2 x 13 in.



Rosebel Slab



Rosebel Slab
Range Newport Grey

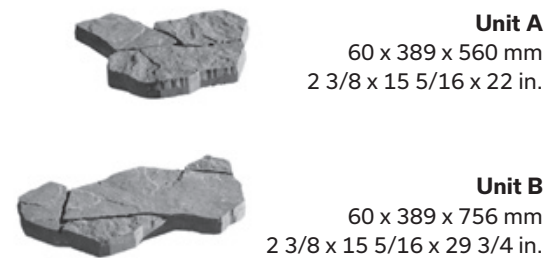

Unit A
60 x 389 x 560 mm
2 3/8 x 15 5/16 x 22 in.

Unit B
60 x 389 x 756 mm
2 3/8 x 15 5/16 x 29 3/4 in.

Wilfrid Slab



Wilfrid Slab
Range Scandinia Grey

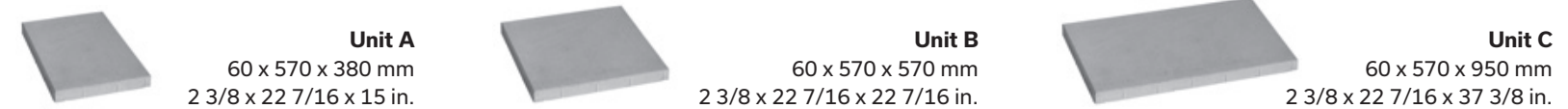
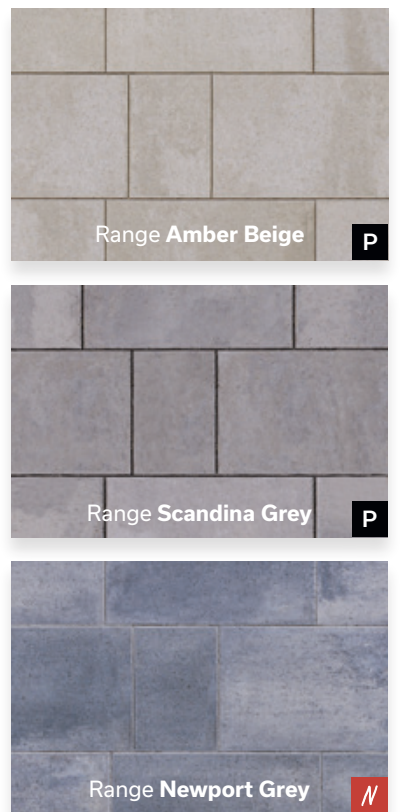

Unit A
60 x 570 x 380 mm
2 3/8 x 22 7/16 x 15 in.

Unit B
60 x 570 x 570 mm
2 3/8 x 22 7/16 x 22 7/16 in.

Unit C
60 x 570 x 950 mm
2 3/8 x 22 7/16 x 37 3/8 in.

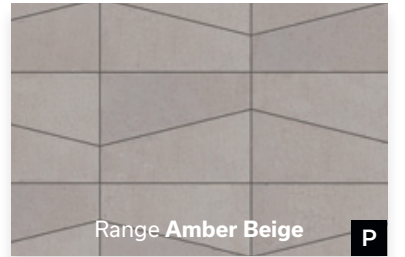

Range Amber Beige **p**



Range Scandina Grey **p**

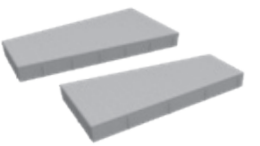

Unit A
60 x 200 and 302 x 610 mm
2 3/8 x 7 7/8 and 11 7/8 x 24 in.

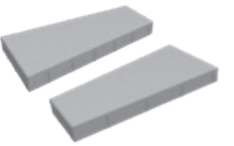

Unit B
60 x 200 and 302 x 610 mm
2 3/8 x 7 7/8 and 11 7/8 x 24 in.



- 50 Brooklyn *New*
- 51 Capio *New*
- 52 Cassara Large Rectangle
- 53 Cassara Verde
- 54 Esbelto DuraFusion 
- 55 Mega Melville
- 56 Melville 80
- 56 Melville 80 Small Rectangle
- 56 Melville 80 DuraFusion 
- 58 Melville Plank
- 59 Mondrian Plus 80
- 59 Mondrian Plus 80 Small Rectangle
- 60 Paleo Plus
- 60 Trafalgar 60
- 61 Vendome 60
- 61 Vendome 80
- 62 Virage
- 63 Zen

Pavers

Brooklyn Paver *New*



Brooklyn Paver
Rosewood and Midnight

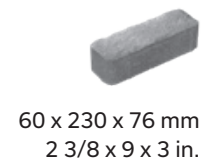
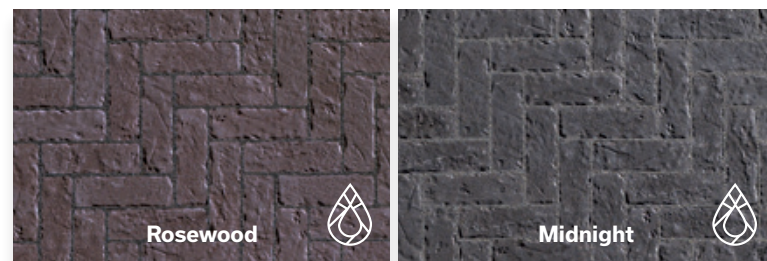

Capio Paver *New*



Capio Paver
Range Scandina Grey and Rockland Black

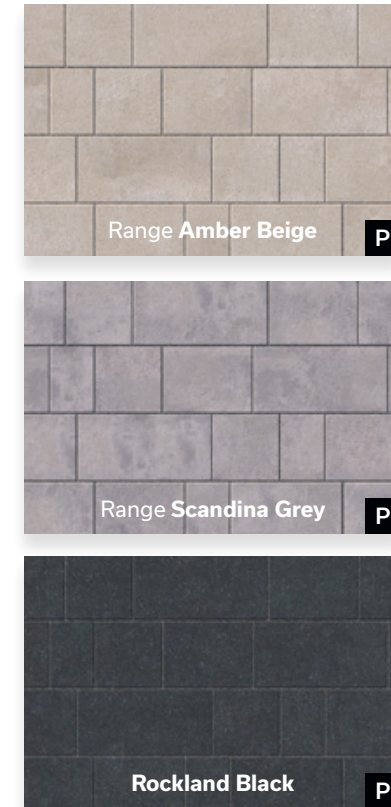

- Unit A**
60 x 152 x 102 mm
2 3/8 x 6 x 4 in.
- Unit B**
60 x 152 x 152 mm
2 3/8 x 6 x 6 in.
- Unit C**
60 x 152 x 203 mm
2 3/8 x 6 x 8 in.
- Unit D**
60 x 152 x 254 mm
2 3/8 x 6 x 10 in.
- Unit E**
60 x 152 x 305 mm
2 3/8 x 6 x 12 in.

Cassara Large Rectangle Paver



Cassara Large Rectangle Paver
Range Shaded Grey

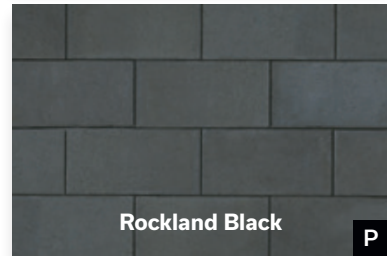
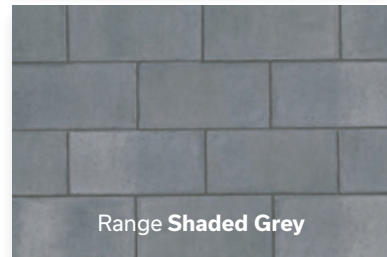
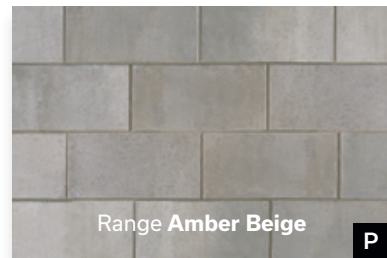

100 x 300 x 700 mm
4 x 11 13/16 x 27 9/16 in.

Cassara Verde Paver



80 x 300 x 450 mm
3 1/8 x 11 13/16 x 17 3/4 in.

Cassara Verde Paver
Range Shaded Grey

Esbelto DuraFusion Paver



Esbelto DuraFusion Paver
Silverstone

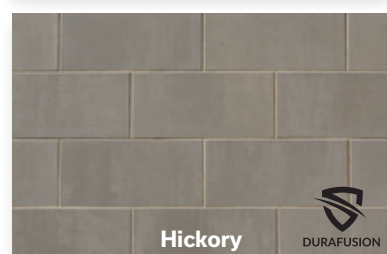
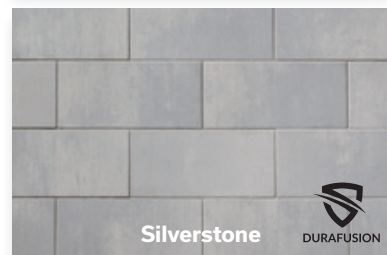

80 x 305 x 610 mm
3 1/8 x 12 x 24 in.

Mega Melville Paver



Mega Melville Paver
Range Newport Grey

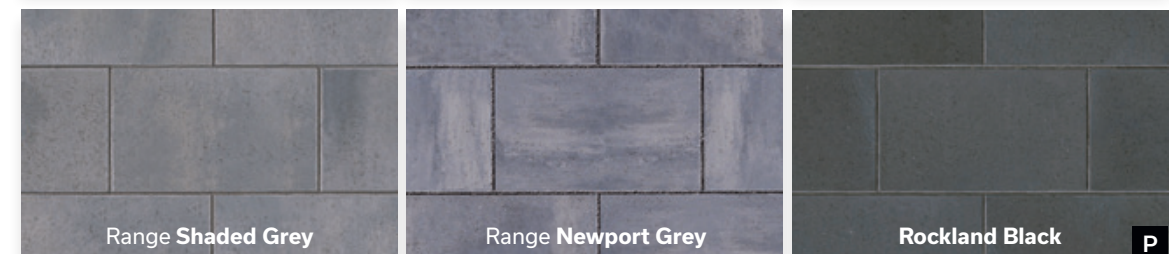

80 x 570 x 950 mm
3 1/8 x 22 7/16 x 37 3/8 in.

Melville 80 Paver

For more information  

smooth  

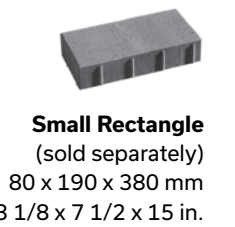
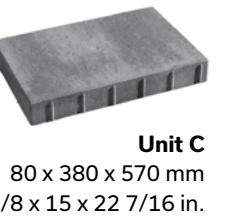
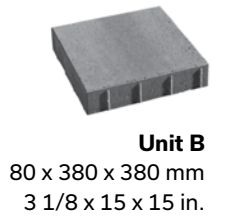
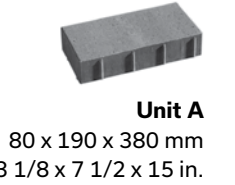
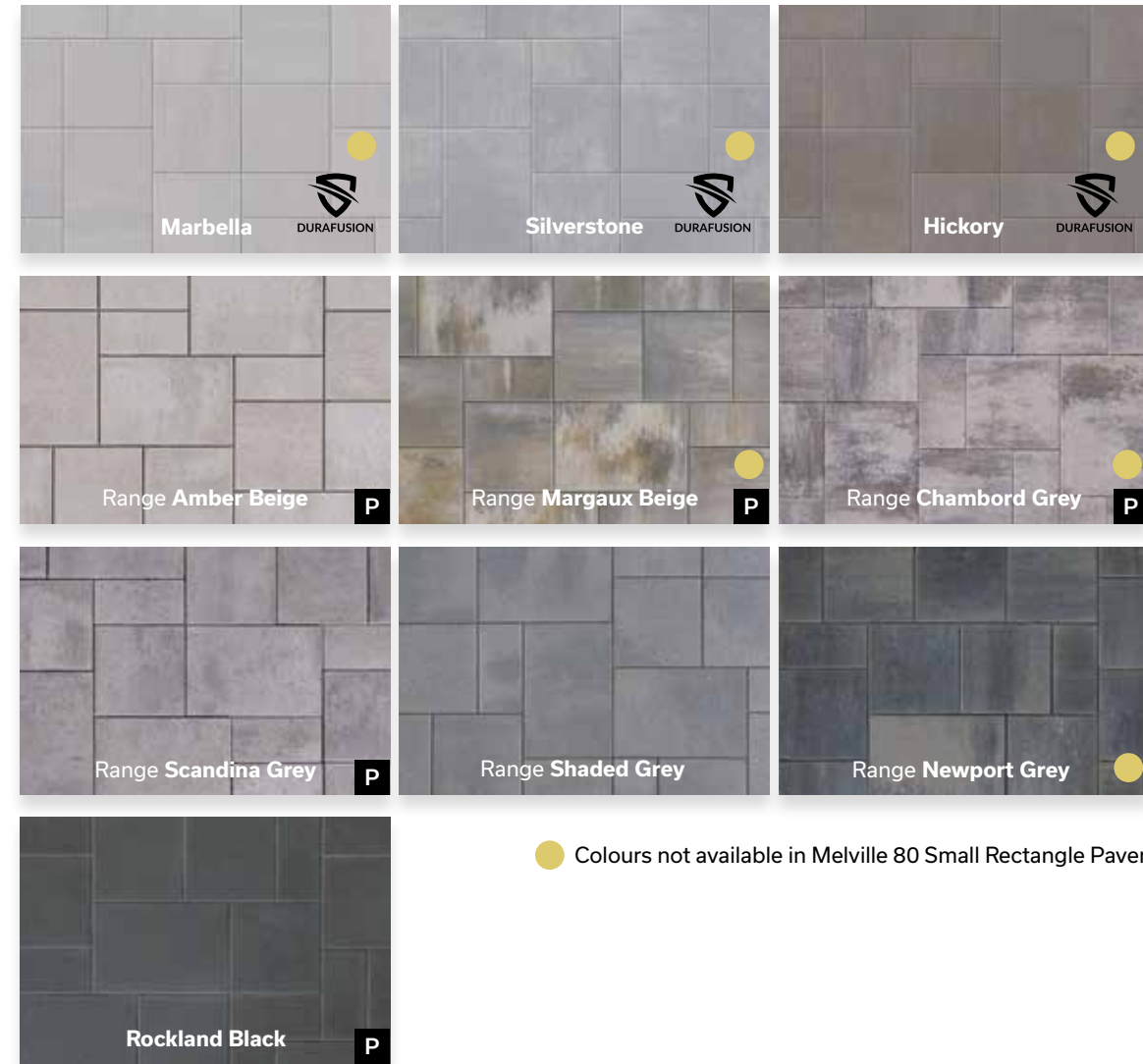

Melville Plank Paver



Melville Plank Paver
Range Scandina Grey



SLIM - A, B and C Units
80 x 127 x 300 - 400 - 500 mm
3 1/8 x 5 x 11 13/16 - 15 3/4 - 19 11/16 in.



LARGE - A, B and C Units
80 x 190 x 300 - 400 - 500 mm
3 1/8 x 7 1/2 x 11 13/16 - 15 3/4 - 19 11/16 in.

Mondrian Plus 80 Paver



Mondrian Plus 80 Paver
Range Newport Grey

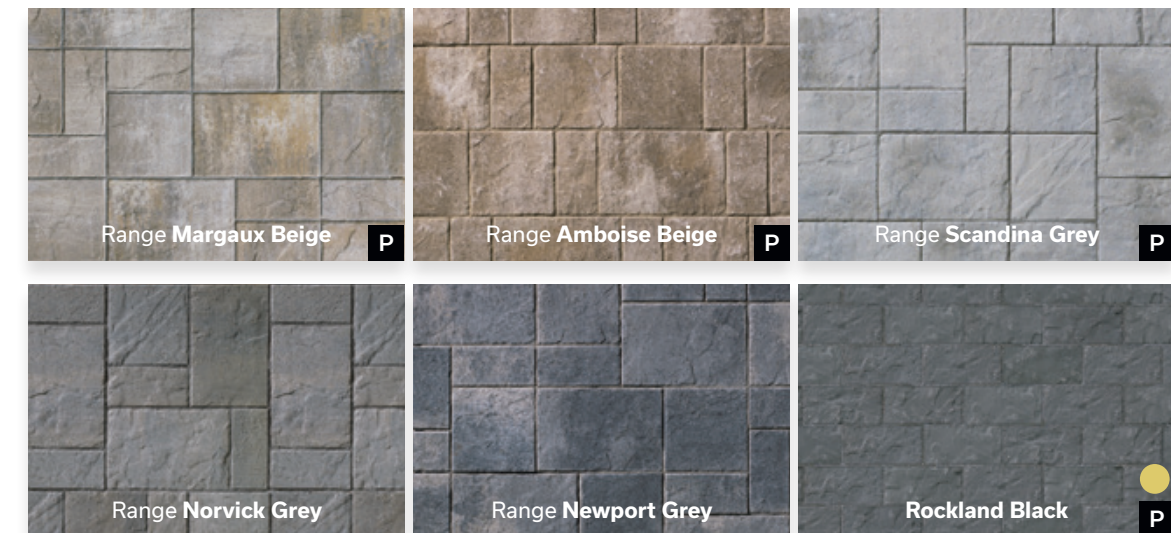

● Colour available in Mondrian Plus 80 Paver Small Rectangle only



Unit A
80 x 165 x 330 mm
3 1/8 x 6 1/2 x 13 in.

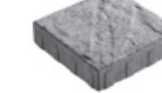

Unit B
80 x 330 x 330 mm
3 1/8 x 13 x 13 in.

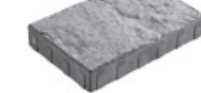

Unit C
80 x 330 x 495 mm
3 1/8 x 13 x 19 1/2 in.



Small Rectangle
(sold separately)
80 x 165 x 330 mm
3 1/8 x 6 1/2 x 13 in.

Paleo Plus Paver



Paleo Plus Paver
Range Bourbon Beige



Range Bourbon Beige



Range Norvick Grey



A and B units

A : 60 x 150 x 130 mm
2 3/8 x 5 7/8 x 5 1/8 in.
B : 60 x 150 x 150 mm
2 3/8 x 5 7/8 x 5 7/8 in.



C and D units

C : 60 x 150 x 170 mm
2 3/8 x 5 7/8 x 6 11/16 in.
D : 60 x 150 x 188 mm
2 3/8 x 5 7/8 x 7 3/8 in.

Trafalgar 60 Paver



Trafalgar 60 Paver
Range Margaux Beige



Range Amboise Beige



Range Margaux Beige



Range Newport Grey



Range Norvick Grey



Unit A

60 x 100 x 200 mm
2 3/8 x 3 15/16 x 7 7/8 in.



Unit B

60 x 200 x 200 mm
2 3/8 x 7 7/8 x 7 7/8 in.



Unit C

60 x 200 x 300 mm
2 3/8 x 7 7/8 x 11 13/16 in.

Vendome 60 and 80 Paver



Vendome 80 Paver
Rockland Black



Range Margaux Beige



Range Newport Grey



Rockland Black



Unit A - 60 mm
60 x 130 x 197 mm
2 3/8 x 5 1/8 x 7 3/4 in.



Unit B - 60 mm
60 x 130 x 262 mm
2 3/8 x 5 1/8 x 10 5/16 in.



Unit C - 60 mm
60 x 130 x 327 mm
2 3/8 x 5 1/8 x 12 7/8 in.



Unit A - 80 mm
80 x 130 x 197 mm
3 1/8 x 5 1/8 x 7 3/4 in.



Unit B - 80 mm
80 x 130 x 262 mm
3 1/8 x 5 1/8 x 10 5/16 in.



Unit C - 80 mm
80 x 130 x 327 mm
3 1/8 x 5 1/8 x 12 7/8 in.

Vendome 60 Pavers are not vehicular.

Virage Paver



Range Scandina Grey P



80 x 300 x 300 mm
3 1/8 x 11 7/8 x 11 7/8 in.

Virage Paver
Range Scandina Grey

Zen Paver



Range Amber Beige P



Range Scandina Grey P

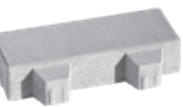

80 x 190 x 380 mm
3 1/8 x 7 1/2 x 15 in.

Zen Paver
Range Scandina Grey

- 66 Celtik
- 67 Grande
- 68 Lafitt Tandem
- 69 Melville Tandem
- 70 Orion
- 71 Urbano
- 72 Vario

Walls

Celtik Wall



Celtik Wall
Range Sheffield Beige and Black

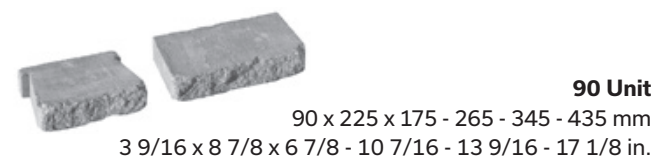

Grande Wall



Grande Wall
Grey



● Colours available in 438 Capping and 175 Step only

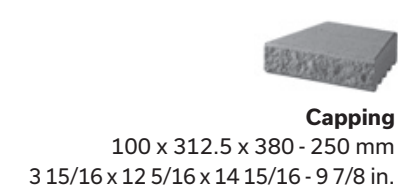
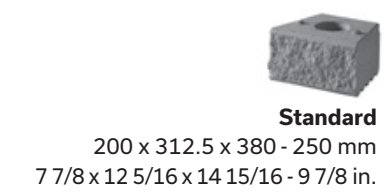

GRANDE WEDGE

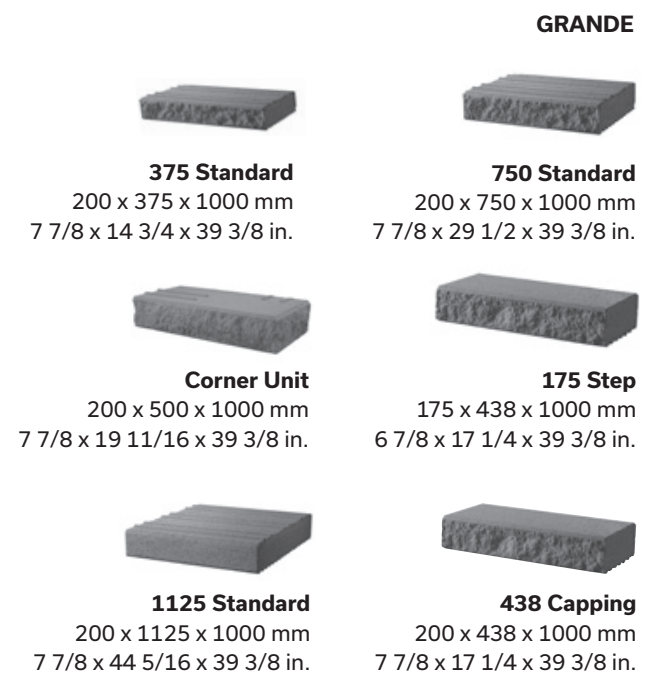

Lafitt Tandem Wall



Lafitt Tandem Wall
Range Margaux Beige

Melville Tandem Wall



Melville Tandem Wall
Range Newport Grey



● Available in the 180 units only



90 - A, B, C and D Units
90 x 67 x 201 - 268 - 335 - 402 mm
3 9/16 x 2 5/8 x 7 7/8 - 10 1/2 - 13 3/16 - 15 13/16 in.



180 - E, F and G Units
180 x 67 x 335 - 402 - 469 mm
7 x 2 5/8 x 13 3/16 - 15 13/16 - 18 1/2 in.



90 - A, B, C and D Units
90 x 67 x 201 - 268 - 335 - 402 mm
3 9/16 x 2 5/8 x 7 7/8 - 10 1/2 - 13 3/16 - 15 13/16 in.



180 - E, F and G Units
180 x 67 x 335 - 402 - 469 mm
7 x 2 5/8 x 13 3/16 - 15 13/16 - 18 1/2 in.

Orion Wall

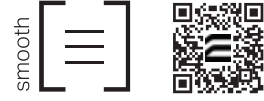

Orion Wall
Range Scandina Grey

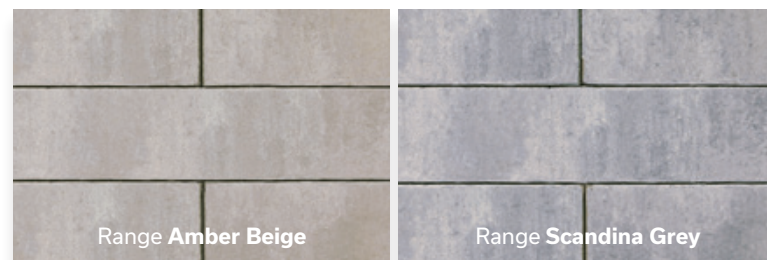

Urbano Wall





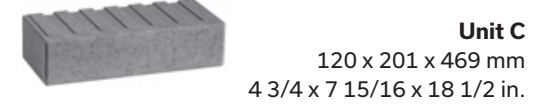
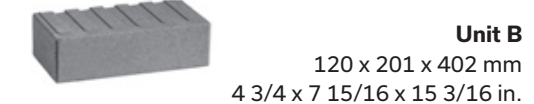
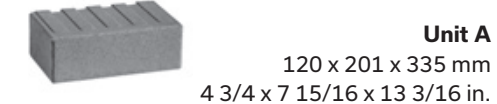
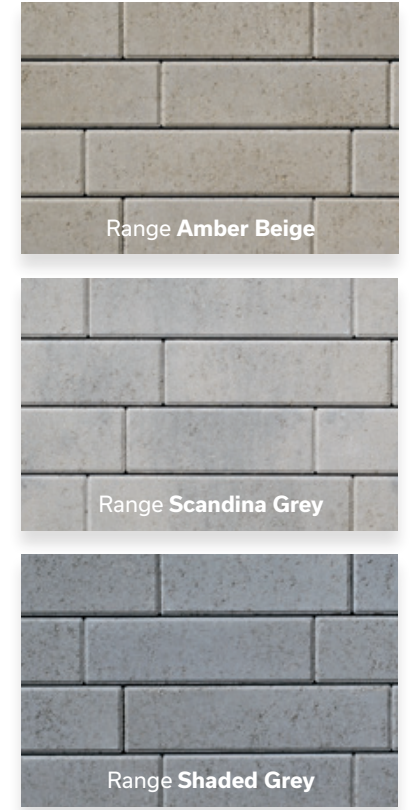



Urbano Wall
Range Scandina Grey

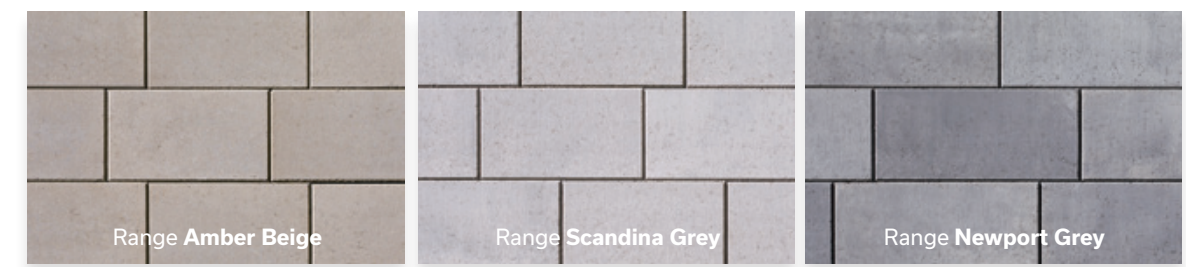



Vario Wall
Range Amber Beige



 90 - Unit A 90 x 238 x 317.5 mm 3 9/16 x 9 3/8 x 12 1/2 in.	 90 - Unit B 90 x 238 x 397 mm 3 9/16 x 9 3/8 x 15 5/8 in.	 90 - Unit C 90 x 238 x 476.5 mm 3 9/16 x 9 3/8 x 18 3/4 in.
 180 - Unit A 180 x 238 x 317.5 mm 7 x 9 3/8 x 12 1/2 in.	 180 - Unit B 180 x 238 x 397 mm 7 x 9 3/8 x 15 5/8 in.	 180 - Unit C 180 x 238 x 476.5 mm 7 x 9 3/8 x 18 3/4 in.



CAPPING

- 76 Lafitt Plus
- 78 Laguna
- 79 Leno Bullnose
- 79 Leno Lafitt *New*
- 79 Leno Straight *New*
- 80 Marina
- 81 Melville Plus 60 and 90 *New*
- 83 Mondrian Plus

STEPS

- 77 Lafitt Plus
- 82 Melville Plus 60 and 90

Capping and Steps

Lafitt Plus Capping



90 x 305 x 400 mm
3 9/16 x 12 x 15 3/4 in.

Lafitt Plus Capping
Range Scandina Grey

Lafitt Plus Step



90 x 400 x 400 mm
3 9/16 x 15 3/4 x 15 3/4 in.

Lafitt Plus Step
Range Margaux Beige

Laguna Pool Capping



Laguna Pool Capping
Alpine Grey

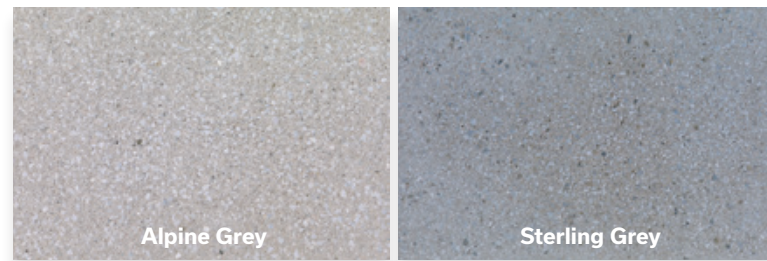

Leno Capping

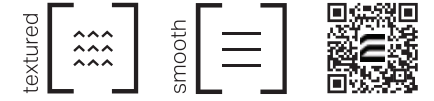

Leno Bullnose Capping
Range Scandina Grey

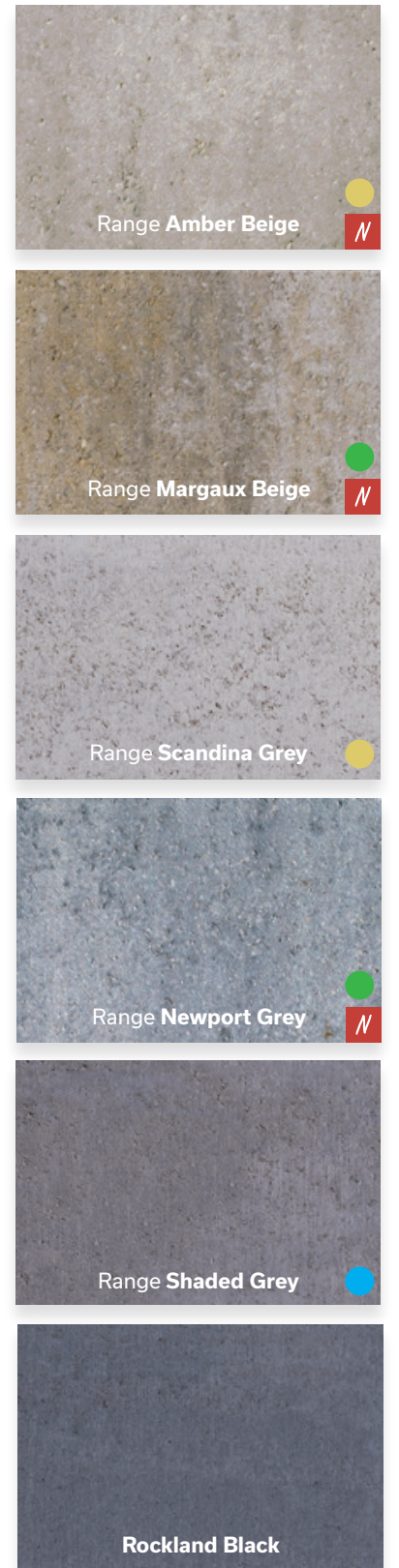

60 x 360 x 610 mm
2 3/8 x 14 3/16 x 24 in.

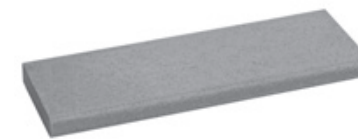

Leno Bullnose
60 x 305 x 915 mm
2 3/8 x 12 x 36 in.

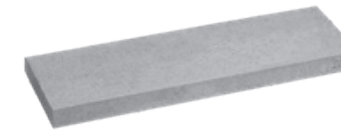

New **Leno Straight**
60 x 305 x 915 mm
2 3/8 x 12 x 36 in.



New **Leno Lafitt**
60 x 305 x 915 mm
2 3/8 x 12 x 36 in.

- Colours available in Leno Bullnose and Straight only
- Colours available in Leno Lafitt only
- Colour available in Leno Bullnose only

Marina Capping



Marina Capping
Rockland Black



Range Scandina Grey *N*

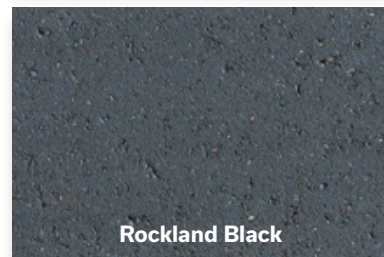

Rockland Black

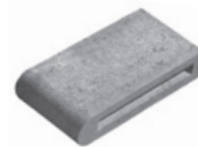

60 x 150 x 300 mm
2 3/8 x 5 15/16 x 11 13/16 in.

Melville Plus 60 and 90 Capping



Melville Plus 60 Capping
Range Scandina Grey



Range Amber Beige



Range Margaux Beige

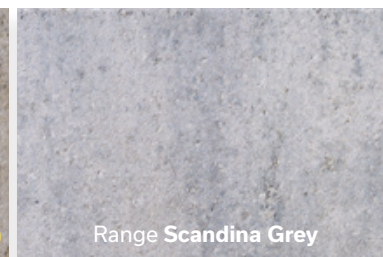

Range Scandina Grey



Range Shaded Grey



Range Newport Grey

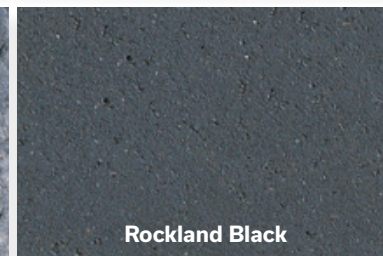

Rockland Black

Colours available in Melville Plus 60 Capping only

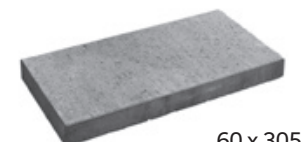

60 Unit
60 x 305 x 600 mm
2 3/8 x 12 x 23 5/8 in.

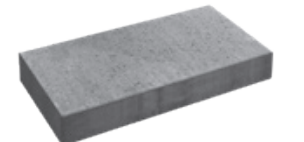

New
90 Unit
90 x 305 x 600 mm
3 9/16 x 12 x 23 5/8 in.

Melville Plus 60 and 90 Steps



Melville Plus 60 Step
Range Scandina Grey

Mondrian Plus Capping



Mondrian Plus Capping
Range Norvick Grey

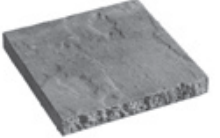
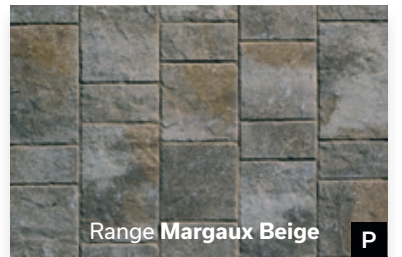

50 x 406 x 375 mm
2 x 16 x 14 3/4 in.



● Colours available in Melville Plus 90 Step only

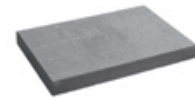

60 Unit
60 x 400 x 600 mm
2 3/8 x 15 3/4 x 23 5/8 in.

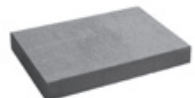

90 Unit
90 x 400 x 600 mm
3 9/16 x 15 3/4 x 23 5/8 in.



86 Mega Lafitt Plus

87 Mega Melville Plus

Mega Steps

Mega Lafitt Plus Step



Mega Lafitt Plus Step
Rockland Black



180 x 406 x 1219 mm
7 x 16 x 48 in.

Mega Melville Plus Step



Mega Melville Plus Step
Range Scandinia Grey

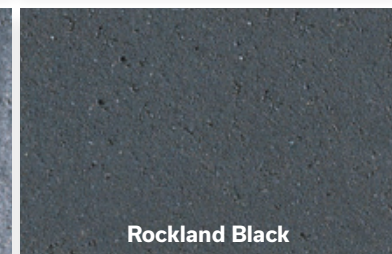
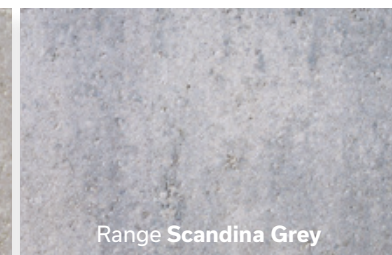

180 x 406 x 1219 mm
7 x 16 x 48 in.



- 90 Celtik
- 90 Mega Celtik
- 91 Lafitt
- 92 Melville
- 93 Novo *New*

Curbs

Celtik Curb and Mega Celtik Curb



Lafitt Curb



Celtik Curb
Range Sheffield Beige and Black



Lafitt Curb
Range Newport Grey



Range Sheffield Beige and Black

Range Norvick Grey



Celtik Curb
110 x 90 mm x var.
4 5/16 x 3 9/16 in. x var.



Mega Celtik Curb
200 x 115 x 300 mm
7 7/8 x 4 1/2 x 11 13/16 in.



Range Margaux Beige



Range Newport Grey



Range Rockland Black



125 x 115 x 600 mm
4 7/8 x 4 1/2 x 23 5/8 in.

Melville Curb



Melville Curb
Rockland Black

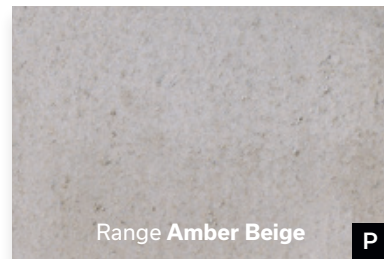

Range Amber Beige P



Range Scandina Grey P

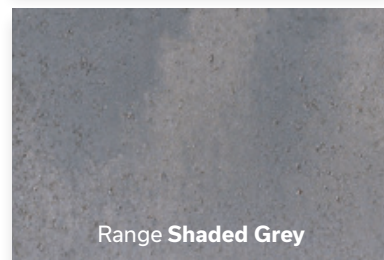

Range Shaded Grey



Rockland Black P



125 x 115 x 600 mm
4 7/8 x 4 1/2 x 23 5/8 in.

Novo Curb *New*



Novo Curb
Rockland Black

808



Range Amber Beige P

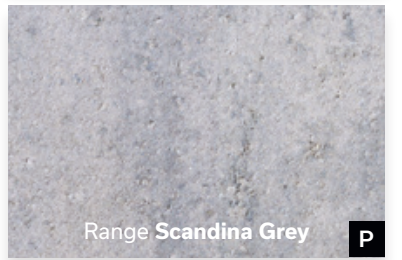

Range Scandina Grey P

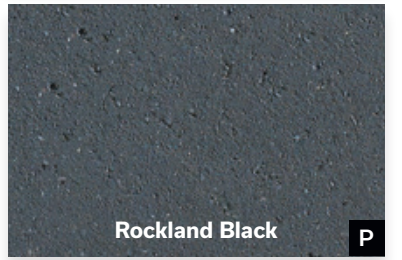

Rockland Black P



178 x 152.5 x 610 mm
7 x 6 x 24 in.

95 Noon
95 Quarziti 2.0

Mirage

Porcelain tiles, natural stone finishes and wood texture bring materials in harmony with nature.



Quarziti 2.0 Large Square Glacier and Mantle

NOON Porcelain Tiles



Noon Daylight

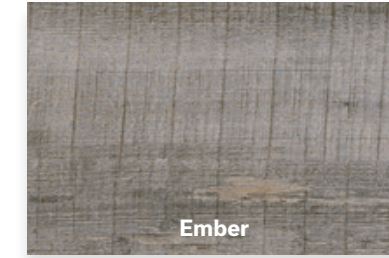
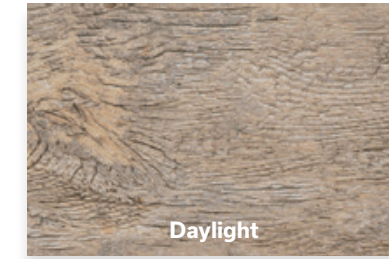

20 x 300 x 1200 mm
3/4 x 11 13/16 x 47 1/4 in.

Quarziti 2.0 Porcelain Tiles



Quarziti 2.0 Large Square Waterfall

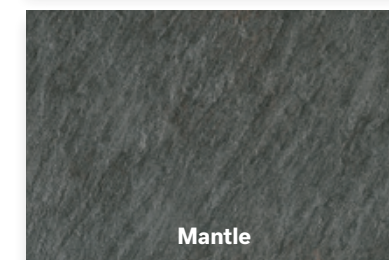
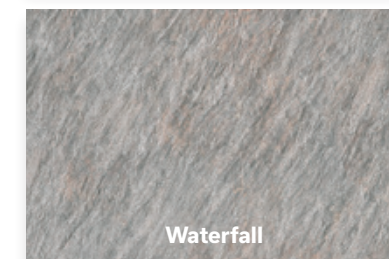

Large Rectangle
(sold separately)
20 x 600 x 1200 mm
3/4 x 23 5/8 x 47 1/4 in.

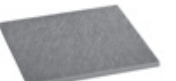

Large Square
(sold separately)
20 x 600 x 600 mm
3/4 x 23 5/8 x 23 5/8 in.



Pool Capping
(sold separately)
20 x 330 x 600 mm
3/4 x 13 x 23 5/8 in.

Techniseal® Polymeric Sands



SMARTSAND® with NextGel™ TECHNOLOGY

- Optimizing interlocking paver jointing
 - Ideal for 1/16 in. (1.6 mm) to 1 in. (2.5 cm) wide joints
 - Suitable for pedestrian and low-traffic areas (driveways, sidewalks and terraces)
- SmartSand is offered by Permacon in **Tan, Urban Grey or Granite**



HP NextGel

- Optimizing jointing of concrete pavers and slabs, and porcelain tiles (only if mechanical compaction is possible)
 - Appropriate for false joints
 - Ideal for 1/16 in. (1.6 mm) to 2 in. (5 cm) wide joints
 - Suitable for high-humidity environments, heavy-sloped and heavy traffic areas
- HP NextGel is offered by Permacon in **Tan, Urban Grey, Ivory, Black or Granite**



N RG+ POLYMERIC SAND SABLE POLYMERÉ NextGel

- Economic solution
 - Ideal for 1/16 in. (1.6 mm) to 1/2 in. (12.7 mm) wide joints
 - Suitable for everyday projects
- RG+ NextGel is offered by Permacon in **Tan or Dark Granite**

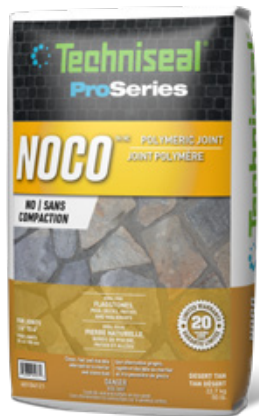

N NOCO NO COMPACTION

- Optimizing jointing of concrete pavers, highly textured surfaces, large slabs and porcelain tiles
 - Appropriate for false joints
 - Ideal for 1/4 in. (6 mm) to 2 in. (5 cm) wide joints with up to 4 in. (10 cm) wide intersections
 - Perfect alternative to mortar, stone dust and polymeric stone dust
- Noco is offered by Permacon in **Desert Tan or Iron Grey**



Tan



Urban Grey



Ivory

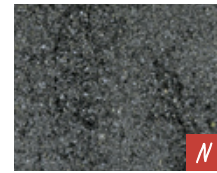

Black

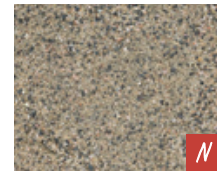

Granite

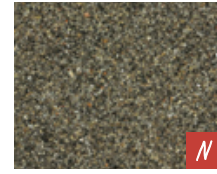

Dark Granite



Desert Tan

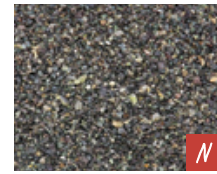

Iron Grey

All the tools you need to design your project



VISUALIZATION TOOL

Create, dare, change, start again... in complete freedom!



MAINTENANCE

Protect your investment



INSPIRATION

Let yourself be inspired by our gallery of projects



Permacon.ca

50-Year Warranty

Landscape Products



50-Year Warranty | **Landscape Products**



Permacon's 50-year warranty applies to landscape and masonry products including Suretouch intended for residential use¹. This warranty statement affirms that products manufactured by Permacon meet the requirements of CSA (Canadian Standard Association) and ASTM (American Society for Testing and Materials) standards.

For details regarding commercial applications, please refer to our institutional, commercial and industrial warranty.

Permacon guarantees that, as of the date of delivery, its concrete products are free from manufacturing defects. Provided that the conditions set forth below are met, Permacon guarantees the structural integrity of the concrete in its landscaping and masonry products for a period of 50 years from the date of the product's purchase. The warranty applies to normal, non-abusive use of the product. To preserve the original appearance of your products, we recommend that you consult our **Landscape Maintenance Guide** available on our website.

IN ALL CASES DETAILED BELOW, THE WARRANTY IS LIMITED TO THE PRODUCTS' MARKET VALUE.

How do I make a claim?

 permacon.ca/en/warranty/



Proof of purchase is required to proceed with a claim request. No claims will be accepted without proof of purchase.²

All claims must be reported within 15 days of the discovery of a product's defect. To validate a claim, a Permacon representative will arrive to inspect the defective products in order to confirm whether the claim is eligible. Therefore, it is essential to provide Permacon with the necessary access to inspect and take photos of the affected products.

This warranty is the only one that is presently offered. Because Permacon continually improves and modifies its products, it may alter and discontinue products at any time, and therefore may replace warranty-covered products with products of similar quality or offer monetary compensation if the products under warranty have been discontinued or are no longer on the market while the warranty is active.

In the event that a product is found to be non-compliant by Permacon or an authorized representative of the company, and in order to proceed with compensation, Permacon will take into account the number of months during which the

landscape or masonry products were in the possession of the owner or their contractor, up to the date of the claim, and will prorate the amount of the payment or replacement to be made accordingly.

For example, if the purchaser makes a warranty claim in the last month of the 10th year of the warranty (i.e., the 120th month), the manufacturer, at its sole discretion, shall either:

- Provide a replacement for the product in question if still available (only the defective product will be replaced);
- Return 480/600 of the price paid for the products to the owner. No labour, transportation, or other compensation will be covered by Permacon.

Transferability

The warranty is transferable. Proof of warranty registration will still be required in the event of a claim. The prorated period will be based on the 50-year warranty period remaining as an assignee, if the purchaser transfers the warranty to a subsequent owner, as described above.

Exclusions

A landscape or masonry product installed on an area of more than **100 square feet** confirms the acceptance of the product received on the job site and that no claim can be made to Permacon regarding the colour, size, or texture of the product.

This warranty excludes all products not supplied by Permacon, as well as any defects, failures, or damages that may result from the actions listed below:

- Contact with chemicals or cleaning products;
- Damage caused by pressure washers;
- Improper installation or other construction activities that do not comply with the installation standards established by ICPI, NCMA or IMQ, the National Building Code or the installation methods and tips recommended by Permacon. The installation guides provided by Permacon represent certain installation situations and are not exhaustive. It is therefore strongly recommended that you consult a qualified professional to ensure the proper installation of Permacon products on a specific job site;
- Defective design or construction resulting in sagging, shifting, or failure;
- Breakage due to shock, impact, or excessive load during handling, use, or transportation;
- Natural disaster or other uncontrollable event;
- Breakage and damage to products caused by soil movement or building movement as well as misuse of construction, compaction, or snow removal equipment. The warranty does not cover surface deterioration caused by the misuse of sodium chloride (NaCl) to de-ice pavers, slabs, or steps;
- The use of sodium chloride (NaCl) on the following products:
 - Step Valentia;
 - Valentia Block;
- Be.OnStone and Mirage products sold by Permacon.

Installation

When installing masonry products, all work must be cleaned to remove any residues and contaminants left on the stone or brick. Permacon accepts no responsibility for stains and colour changes caused by installation residue or the consequences of cleaning these residues.

Colour

The presence of natural ingredients used in the manufacturing process varies from one product to another. Therefore, the product received on the job site will not be completely identical to the products displayed in our commercial presentations (catalogs, samples, displays). Any difference in colour will not be covered by the guarantee.

Photos of our products in landscape and masonry brochures, as well as in displays such as masonry panels and landscape racks at our distributors, are not an exact representation of the products that will be delivered to the job site. Permacon offers a variety of products with different colours to reproduce the appearance of natural stone. It is therefore strongly recommended that you view several products directly from your authorized Permacon distributor to see all available colours.

It is the purchaser's responsibility to approve the products (and their colour) delivered to the job site prior to installation to confirm satisfaction. It is also recommended to mix products from different pallets received on the job site. Since variations in colour shades are a natural phenomenon, Permacon does not guarantee colour uniformity between different pallets on the same job site. Product installation constitutes acceptance.

Polymeric film

A whitish polymeric film can be found on the surface of Permacon's products. This is the result of an inadequate use of polymeric sand. Improper cleaning of slabs and pavers prior to the application of water on the product surface can cause this whitish polymeric film. This film does not affect the structural integrity of the product. Permacon cannot be held responsible for this phenomenon, which is not covered by the warranty.

Efflorescence

White traces on the surface of the product are caused by a natural phenomenon called efflorescence. More visible on darker products, efflorescence affects neither the intrinsic technical qualities nor the structural integrity of Permacon's products. The possible appearance of efflorescence cannot be the subject of any guarantee. In most cases, efflorescence disappears by itself over time.

Our Preventive Maintenance Guide for Concrete Landscaping Products is available on our website permacon.ca

¹ The following locations are defined as residential: family dwelling of five units or less, single family homes, garden suites, or townhouses.

² The following documents are considered valid proof of purchase: invoices directly from an authorized Permacon distributor, or invoice from a landscape contractor, general contractor, mason, or home builder.



Since 1952, all Permacon products have been made with passion and pride in Canada.



[permacon.ca](https://www.permacon.ca)



1 888 PERMACON

PERMACON
A CRH COMPANY